

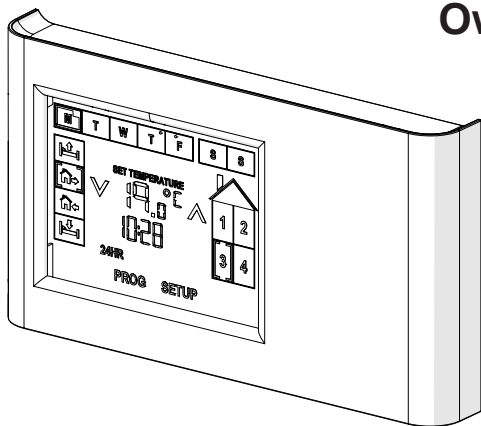

Owner's Manual

Model
CX-MPC













IMPORTANT SAFETY INFORMATION: Always read this manual first before attempting to install or use this device. For your safety, always comply with all warnings and safety instructions contained in this manual to prevent personal injury or property damage.

To view the full line of Dimplex products, please visit www.dimplex.com

7212190100R03



Table of Contents

 Welcome & Congratulations	3
 IMPORTANT INSTRUCTIONS	4
 Product Overview	5
 Wall Setter Installation	7
 Initial Set Up	8
 Program Schedule Set up	10
 General Functions	12
 Operation	15
 Maintenance	17
 Warranty	18
 Reference Tables	19

! NOTE: Procedures and techniques that are considered important enough to emphasize.

⚠ CAUTION: Procedures and techniques which, if not carefully followed, will result in damage to the equipment.

⚠ WARNING: Procedures and techniques which, if not carefully followed, will expose the user to the risk of fire, serious injury, or death.

Welcome & Congratulations

Thank you and congratulations for choosing to purchase a Multi-zone Programmable CONNEX™ Controller from Dimplex.

Please carefully read and save these instructions.

⚠ CAUTION: Read all instructions and warnings carefully before starting installation. Failure to follow these instructions may result in a possible electric shock, fire hazard and will void the warranty.

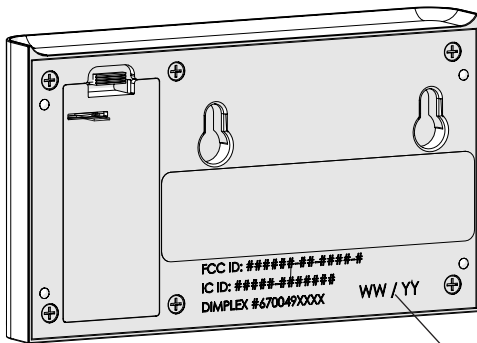

Date Code

STOP NO NEED TO RETURN TO THE STORE

Questions with operation or mounting? Require Parts Information?
Product Under Manufacturer's Warranty?

Contact us at:  www.dimplex.com/customer_support
For Troubleshooting and Technical Support

OR  **Toll-Free 1-888-DIMPLEX (1-888-346-7539)**
Monday to Friday 8:00 a.m. to 4:30 p.m. EST
Please have your model number and product serial number ready. (See above)

IMPORTANT INSTRUCTIONS

 **CAUTION:** This equipment has been tested and found to comply with the limits for Class B digital device, pursuant to part 15 of the FCC Rules. These limits are designed to provide reasonable protection against harmful interference in a residential installation. This equipment generates, uses and can radiate radio frequency energy and, if not installed and used in accordance with the instructions, may cause harmful interference to radio or television reception, which can be determined by turning the equipment off and on, the user is encouraged to try to correct the interference by one or more of the following measures:

- Reorient or relocate the receiving antenna.
- Increase the separation between the equipment and the receiver.
- Connect the equipment into an outlet on a circuit different from that to which the receiver is connected.
- Consult the dealer or an experienced radio/TV technician for help.

This device complies with Part 15 of the FCC Rules. Operation is subject to the following two conditions: (1) This device may not cause harmful interference, and (2) this device must accept any interference received, including interference that may cause undesired operation.

 **FCC CAUTION:** Any changes or modifications not expressly approved by the party responsible for compliance could void the user's authority to operate this equipment.

This device complies with Industry Canada licence-exempt RSS standard(s). Operation is subject to the following two conditions: (1) this device may not cause interference, and (2) this device must accept any interference, including interfer-

ence that may cause undesired operation of the device.

 **WARNING:** Remote control contains small batteries. Keep away from children. If swallowed, seek medical attention immediately.

 **WARNING:** Do not install battery backwards, charge, put in fire or mix with used or other battery types - may explode or leak causing injury.



Product Overview

The Multi-zone Programmable CONNEX™ Controller is a Dimplex exclusive, operating four individual heat zones wirelessly from one remote location.

CONNEX™ wireless technology provides the user the ability to control four individual heat zones for precise temperature management throughout the home. The easy-to-use touch screen allows for 7-day/ 4-event programming that combines with zone heating for incredible energy savings.

Multi-zone Programmable CONNEX™ Controllers link wirelessly to Dimplex CONNEX™ enabled heaters to provide simple whole home control.

Zones

The controller is set up so that the user can divide their house into to up to 4 different heating zones. These can be separate heaters or a selection of one or more heaters that will all be set to run at the same time and temperature settings.

By dividing the house into zones you can program the controller to raise the temperature in particular rooms during the time you normally use them and reduce the

temperature when they are not in use.

By having a wireless controller the components within a zone do not have to be located in the same area of the house, as with traditional heating systems. The components in any particular zone can be spread all through the house.



For example:

- Zone 1 - All of the bedrooms,
- Zone 2 - All of the bathrooms,
- Zone 3 - Kitchen and Living room.

⚠ CAUTION: Zones can be set up as any combination of the Dimplex electronic controlled heaters as long as there is one heater that is within 15m (50ft) of the controller and the subsequent heaters are within 15m (50ft) of the controller or any other heater.

Events



The controller has been designed to divide each day into 4 different time settings for each day– Wake, Away, Home and Sleep.

-  Wake – Initial increase of heat to desired temperature use.
-  Away – A decreased temperature set point while



Product Overview

the area is not in use.

-  Home – An increased temperature set point for normal usage.
-  Sleep – Reduce temperature set point while you are sleeping.

! NOTE: When programming times for temperature events to take place, adjust the time setting so that temperature begins to increase before you will want it to be, i.e. your kitchen takes 17 minutes to increase in temperature from 18°C to 21°C, set the Home Event to occur 17 minutes before you arrive home.

As a default, values have been programmed for the Wake and Sleep times and temperatures for all 4 zones, for all 7 days.

Wake: 21.0°C (70.0°F), 6:00AM

Sleep: 18.0°C (64.0°F), 11:00PM

! NOTE: There are no initial settings for Home and Away events.

To change these values there is a program function which will guide you through the adjustment/set up of these values for a single day or group of days, or multiple zones.

! NOTE: You do not need to

have settings for all events. An event can be skipped by entering --:-- for the time entry. (Increase time to 11:59pm/23:59, the next number will be --:-- before it continues to 12:00am/00:00.)

Wall Setter Installation

Site Selection for Installation

When choosing a location for the Multi-zone Controller a convenient and accessible location should be chosen. The range of the Controller is approximately 50 feet (15 m).

The Multi-zone Controller can control multiple Dimplex CONNEX™ heaters outside of the 50 ft (15 m) range by ensuring that subsequent components in the system are within 15m (45ft) of any other component in the system for the entire system to operate.

1. Remove the Multi-zone Controller and installation hardware from its package.
2. Remove the Insulating Strip as shown in Figure 1.
3. Using the Wall Mounting Bracket, mark and drill the holes for the wall anchors.
4. Install the screws through the Wall Mounting Bracket and into the anchors.

! NOTE: Ensure that the flat side of the Wall Mounting Bracket is against the wall and the screws are installed so that they rest against the extended portion of

the hole. The space will allow screws to sit in the mounting holes correctly.

5. Slide the Wall Setter onto the screws.

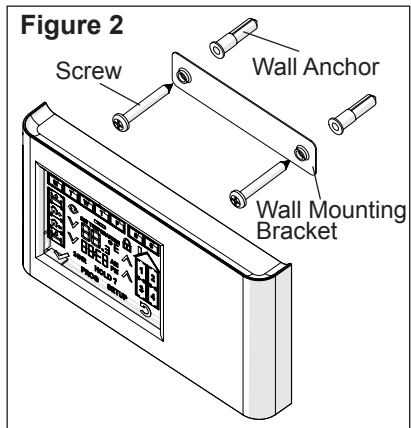
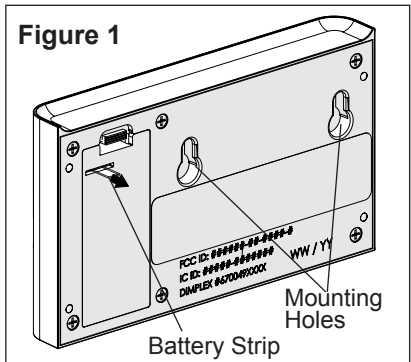

Initial Set Up

Figure 3 - Full Touch Screen Display

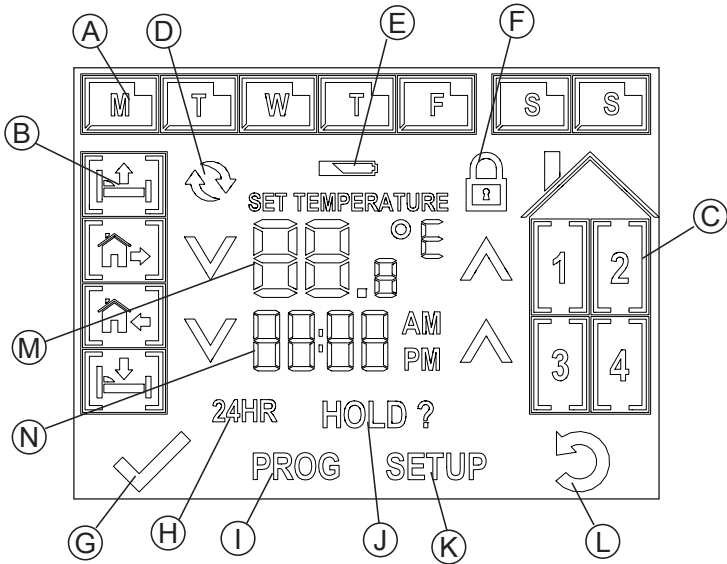

- | | |
|-------------------------|------------------------|
| A. Day Icons | H. 24 Hour Icon |
| B. Event Icons | I. Program Icon |
| C. Zone Icons | J. Hold Icon |
| D. Synchronization Icon | K. Set up Icon |
| E. Low Battery Icon | L. Go Back Icon |
| F. Lock Icon | M. Temperature Display |
| G. Check Icon | N. Time Display |

Initial Set Up





Once the Battery strip has been removed from the unit the Set up program will begin. The initial set-up includes: Day, Type of Clock (12hr or 24hr), Current Time and Temperature Measurement Preference.

⚠ CAUTION: Always press the icons with a blunt object. Sharp objects like pen and pencil points may damage the touch screen.

1. Select the current day of the week, by pressing the icon on the screen.





! NOTE: As each selection is made, the selected icon will become solid and the Check Icon  will appear to move to the next option.

2. Press the Check Icon  to save selection.
3. The default type of clock is a 12hr, the clock can be changed to a 24hr, by pressing the  icon. (To revert back, press the  icon.)
4. Using the  and  icons, you can then set the time.

! NOTE: If the button is held

down for longer the time will increase faster.

! NOTE: If you notice that the wrong day has been selected you can press the Go Back Icon  to revert to the previous screen.

5. Press the Check Icon  to save selection.
6. The °C icon will begin to flash as the default. To switch to °F, press the flashing °C.
7. Once the day, time and temperature preference have been set, press the Check Icon  to go into operation mode.

! NOTE: If the time needs to be adjusted, after this set up, you can press and hold the time display for 3 seconds, to go into the time adjustment mode or press set up to adjust all of the settings.

! NOTE: At any time holding down the temperature set point will toggle the temperature measurement preference.

👉 Program Schedule Set up

Program Set up "Quick Set"

The program function guides the user through the set up for each of the time settings (Wake, Away, Home and Sleep) based on the selected zones to set the desired temperatures.

! NOTE: It is recommended that the main overall general programming be done first - i.e. Bedrooms during the work week and program the entire day, then perform another set up for another zone to speed up the programming. After the main programming is complete, fine tuning can be done on a single day, zone or event basis.



! NOTE: There is a blank setting table at the back of this manual to assist with ensuring that all of the required events and zones have been set up to the desired times and temperatures.

⚠ CAUTION: Always press the icons with a blunt object. Sharp objects like pen and pencil points may damage the touch screen.

1. Press the **PROG** icon to start the set up. The first setting will be for the Wake Event



The zone icons will begin to flash.

! NOTE: At any time pressing the  icon will return to the previous step. If the  icon is held for 3 seconds it will return to the main operating screen.

2. Select the zone(s) that the settings are going to be applied.







! NOTE: As each zone is selected it will become solid and the remaining zones will continue to flash.

3. Press the  icon.
4. The day icons will begin to flash.



5. Select the days that the settings are going to be applied.

! NOTE: As each day is selected it will become solid and the remaining days will continue to flash.

6. Press the  icon.
7. Using the  and  icons on either side of the time setting, set the time for the Wake event to occur.
8. Press the  icon.
9. Using the  and  icons on

Program Schedule Set up

either side of the temperature setting, set the temperature for the Wake event to adjust to.

10. Press the  icon.
11. Repeat steps 2-10 for each of the other events - Away, Home and Sleep.

! NOTE: There is a blank setting table at the back of this manual to assist with ensuring that all of the required events and zones have been set up to the desired times and temperatures.

Factory Reset

If the programmed settings need to be adjusted significantly, it is possible to Reset the controller back to the Factory settings.

1. Press the **SETUP** icon.
2. Press and hold the **SETUP** icon for 10 seconds.

The unit will return to the initial set up screen. This is the same as removing the battery strip after unpacking.

General Functions

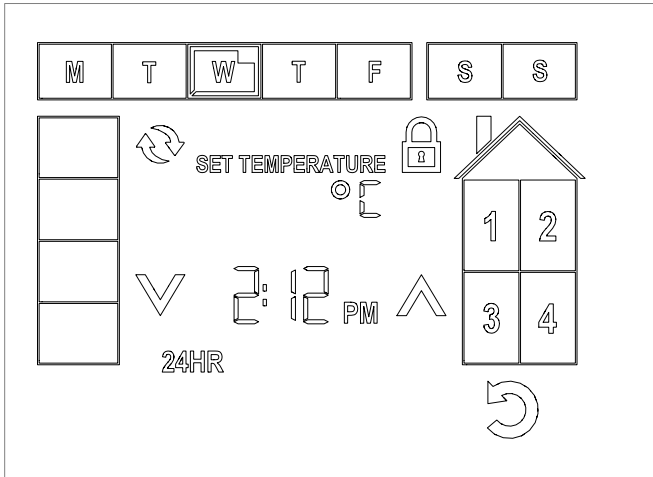

CAUTION: Always press the icons with a blunt object. Sharp objects like pen and pencil points may damage the touch screen.



During regular operation you can press the **SETUP** icon, to make changes to the basic set up of the controller. This includes:

1. Day of the Week
2. Time and/or Type of Clock
3. Temperature Measurement Unit
4. Enable the Sync Function or
5. Enable the Lock Function.

NOTE: If the day, time or temperature measurement preference is adjusted then the synchronization and lock function are no

longer available until the changes have been accepted or reset (the  icon has been pressed).

1. Changing the Day of the Week



When you initially go in to the set up menu the current day of the week will appear, it will be flashing. Select the desired day of the week (the new selection will also be flashing) and the  icon will appear. Press the  icon to save the changes and revert back to operation mode.



NOTE: The time can also be changed by holding down the time display icon for 3 seconds, but

General Functions

only the Day, Time and Type of clock will be displayed to change.

2. Changing the Time

When you initially go into the set up menu the  and  icons for the time adjustment will be flashing and the optional selected time setting will appear (flashing).

Using the  and  icons the time can be adjusted.

! NOTE: If the button is held down for longer the time will increase faster.

By pressing the flashing time setting the time display will change to match the new setting. I.e. 2:12pm will change to 14:12.

As soon as any adjustment is made the  icon will appear.

Press the  icon to save the changes and revert back to operation mode.

! NOTE: The time can also be changed by holding down the time display icon for 3 seconds, but only the Day, Time and Type of clock will be displayed to change.

Press the  icon to save the changes and revert back to operation mode.

3. Changing the Temperature Measurement Unit

When you initially go into the set up menu the temperature will disappear and the temperature measurement icon will begin to flash. By pressing the icon it will toggle between °C and °F.

As soon as any adjustment is made the  icon will appear.

Press the  icon save the changes and revert back to operation mode.

! NOTE: The Temperature Measurement unit can also be changed by holding down the temperature setpoint display for 3 seconds, and it will change to the other Temperature Measurement unit.





4. Synchronization Function

The controller features CONNEX™, a wireless technology that works with Dimplex CONNEX™ enabled heaters to provide simple whole home connectivity and comfort. CONNEX™ controllers are available to control one or multiple heaters within a 50' (15 m) radius. In order for the controller to have this function the CONNEX™ enabled heater and the controller

General Functions

will need to be synchronized.

! NOTE: For ease of synchronization it is suggested that the controller be taken to each heater to complete the synchronization process.

1. Press the  icon, this will put the controller into synchronization mode.
2. All four (4) zone icons will begin to flash.
3. Select the zone that the specific heater will be associated with, that icon will become solid.
4. On the heater press and hold the **V** button for 3 seconds, both the  and  icons will begin to flash.
5. Press the **-**, **+** and then **V**, on the heater.
6. Within 10 seconds press the  icon on the controller.



! NOTE: When the synchronization is complete the display on the heater will switch to the new settings from the controller.

7. Repeat steps 3-5 until all of the heaters are synchronized.
8. Press the  icon to revert back to operation mode.

5. Lock Function

The controller can be "Locked" so that the display on the controller are disabled to prevent any changes to the settings in the system.

To Enable:



1. Press the  Icon.
2. Enter the sequence Zone 1, Zone 2, Zone 3 and Zone 4, then press the  Icon.

The Controller will display the  Icon and continue to operate based on the settings and signals from the controller.

! NOTE: Adjustments can be made to individual heaters by entering it's specific unlock sequence and adjusting the set point.

! CAUTION: The adjusted heater will only retain the new set point until an event occurs on the controller and a new set point is sent.

To Disable:

1. Press and hold the  Icon for 3 seconds.
2. Enter the sequence Zone 1, Zone 2, Zone 3 and Zone 4, then press the  Icon.

Operation

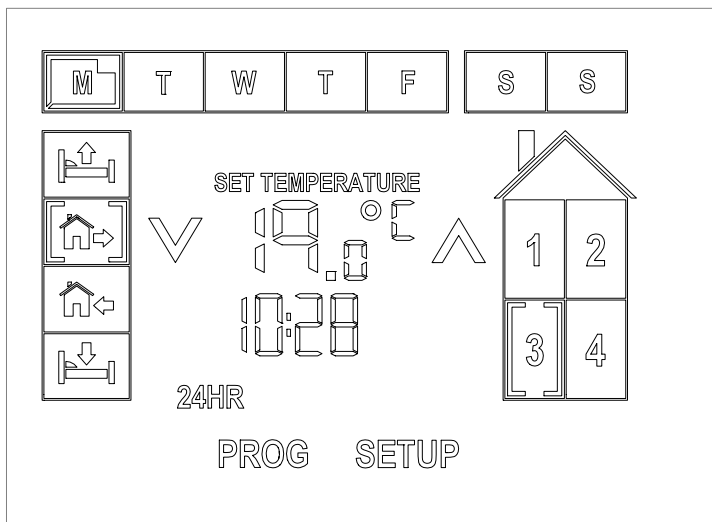

Once the programming is complete and the heaters have been synchronized, the controller has built in functions that can add to the overall flexible benefits of the system.

During regular operation the temperature setting in each Zone can be displayed by selecting the desired Zone.

To see the setting for the next Day or Event for a particular Zone, pressing the corresponding icons will display the setting and set time for 5 seconds, before reverting back to the regular operating screen.

⚠ CAUTION: Always press the icons with a blunt object. Sharp objects like pen and pencil points may damage the touch screen.

Set Point Changes

The user has the option at any time to adjust a particular temperature setting without changing the main program.

There are two types of temperature changes that can be used:



1. Temporary or
2. Indefinite

Temporary Temperature Changes

If the temperature in a particular zone or multiple zones needs to

Operation



be adjusted for the remainder of the current event a Temporary Temperature change can be done.

3. Select the Zone that the temperature change will be applied.
4. Using the  and  icons adjust the set point to the desired temperature.
5. Select additional Zones if needed.

! NOTE: All of the settings will adjust to the programmed settings at the next event for each of the specified zones.

Indefinite Temperature Changes

If the temperature in a particular zone or multiple zones needs to be adjusted for an indefinite period of time an Indefinite Temperature Hold can be done.

1. Select the Zone that the temperature hold will be applied.
2. Using the  and  icons adjust the set point to the desired temperature.
3. Press and hold the **HOLD** Icon.
4. Select additional Zones if needed.

5. Press the  icon to save the changes and revert back to operation mode.

! NOTE: To exit the hold mode, the user can press the  icon. This will remove all holds that have been applied.

Factory Reset

If the programmed settings need to be adjusted significantly, it is possible to Reset the controller back to the Factory settings.

1. Press the **SETUP** icon.
2. Press and hold the  icon for 10 seconds.

The unit will return to the initial set up screen. This is the same as removing the battery strip after unpacking.



Maintenance

The only maintenance required is the replacement of the batteries. When the batteries start to reach the end of their life the controller will display a low battery icon, , above the temperature reading. In conjunction with this a periodic beep (every 2 minutes) will be emitted from the unit until the battery is changed.

To change the battery:

1. Remove unit from wall.
2. Slide battery cover open on the controller.
3. Remove and replace two (2) AA batteries, into the battery holder.

! NOTE: The day and time will have to be reset once the batteries have been replaced, but the program will remain in the memory.

4. Replace cover.
5. Remount on wall.



Battery must be recycled or disposed of properly.

Check with your Local Authority or Retailer for recycling advice in your area.

Figure 4

Batteries

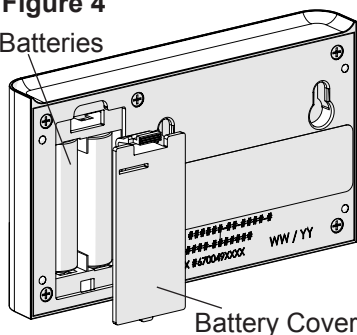

Surface Cleaning

Use a cloth dampened with warm water only to clean housing and glass display of the wall setter. Do not use abrasive cleaners.

If the display needs to be cleaned, putting the unit in the lock function will allow you to remove any fingerprints or dirt without changing any settings.

Warranty

LIMITED WARRANTY: All Dimplex Wall Setters are warranted against defects in workmanship and materials for three years from date of sale. This warranty does not apply to damage from accident, misuse, or alteration, nor to equipment improperly installed or wired or maintained in violation of the instruction sheet. This limited warranty applies only to purchases made in any province of Canada except for Yukon Territory, Nunavut, or Northwest Territories or in any of the 50 States of the USA (and the District of Columbia) except for Hawaii and Alaska. This limited warranty applies to the original purchaser of the product only and is not transferable. No other written or oral warranty applies. No employee, agent, dealer or other person is authorized to give any warranties on behalf of Dimplex. The customer shall be responsible for all costs incurred in the removal or reinstallation and shipping of the product for repairs. Within the limitations of this warranty, inoperative units shall be returned to the nearest Dimplex authorized service center, and we shall repair or replace, at our option, at no charge to you with return freight paid by Dimplex. It is agreed that such repair or replacement is the exclusive remedy available from Dimplex and that DIMPLEX IS NOT RESPONSIBLE FOR DAMAGES OF ANY KIND, INCLUDING INCIDENTAL AND CONSEQUENTIAL DAM-

AGE. Some States do not allow the exclusion or limitation of consequential damages, so the above exclusion or limitation may not apply to you. This warranty gives you specific legal rights and you may also have other rights which vary from state to state.



Reference Tables

Default Settings

		Wake 	Leave 	Home 	Sleep
Monday 	Zone 1	21.0C, 6:00AM	--C, --:--AM	--C, --:--PM	18.0C, 11:00PM
	Zone 2	21.0C, 6:00AM	--C, --:--AM	--C, --:--PM	18.0C, 11:00PM
	Zone 3	21.0C, 6:00AM	--C, --:--AM	--C, --:--PM	18.0C, 11:00PM
	Zone 4	21.0C, 6:00AM	--C, --:--AM	--C, --:--PM	18.0C, 11:00PM
Tuesday 	Zone 1	21.0C, 6:00AM	--C, --:--AM	--C, --:--PM	18.0C, 11:00PM
	Zone 2	21.0C, 6:00AM	--C, --:--AM	--C, --:--PM	18.0C, 11:00PM
	Zone 3	21.0C, 6:00AM	--C, --:--AM	--C, --:--PM	18.0C, 11:00PM
	Zone 4	21.0C, 6:00AM	--C, --:--AM	--C, --:--PM	18.0C, 11:00PM
Wednesday 	Zone 1	21.0C, 6:00AM	--C, --:--AM	--C, --:--PM	18.0C, 11:00PM
	Zone 2	21.0C, 6:00AM	--C, --:--AM	--C, --:--PM	18.0C, 11:00PM
	Zone 3	21.0C, 6:00AM	--C, --:--AM	--C, --:--PM	18.0C, 11:00PM
	Zone 4	21.0C, 6:00AM	--C, --:--AM	--C, --:--PM	18.0C, 11:00PM
Thursday 	Zone 1	21.0C, 6:00AM	--C, --:--AM	--C, --:--PM	18.0C, 11:00PM
	Zone 2	21.0C, 6:00AM	--C, --:--AM	--C, --:--PM	18.0C, 11:00PM
	Zone 3	21.0C, 6:00AM	--C, --:--AM	--C, --:--PM	18.0C, 11:00PM
	Zone 4	21.0C, 6:00AM	--C, --:--AM	--C, --:--PM	18.0C, 11:00PM
Friday 	Zone 1	21.0C, 6:00AM	--C, --:--AM	--C, --:--PM	18.0C, 11:00PM
	Zone 2	21.0C, 6:00AM	--C, --:--AM	--C, --:--PM	18.0C, 11:00PM
	Zone 3	21.0C, 6:00AM	--C, --:--AM	--C, --:--PM	18.0C, 11:00PM
	Zone 4	21.0C, 6:00AM	--C, --:--AM	--C, --:--PM	18.0C, 11:00PM
Saturday 	Zone 1	21.0C, 6:00AM	--C, --:--AM	--C, --:--PM	18.0C, 11:00PM
	Zone 2	21.0C, 6:00AM	--C, --:--AM	--C, --:--PM	18.0C, 11:00PM
	Zone 3	21.0C, 6:00AM	--C, --:--AM	--C, --:--PM	18.0C, 11:00PM
	Zone 4	21.0C, 6:00AM	--C, --:--AM	--C, --:--PM	18.0C, 11:00PM
Sunday 	Zone 1	21.0C, 6:00AM	--C, --:--AM	--C, --:--PM	18.0C, 11:00PM
	Zone 2	21.0C, 6:00AM	--C, --:--AM	--C, --:--PM	18.0C, 11:00PM
	Zone 3	21.0C, 6:00AM	--C, --:--AM	--C, --:--PM	18.0C, 11:00PM
	Zone 4	21.0C, 6:00AM	--C, --:--AM	--C, --:--PM	18.0C, 11:00PM



Reference Tables











Sample Settings

Zone 1: Bedroom 1, 2, 3

Zone 3: Kitchen

Zone 2: Bathroom 1, 2

Zone 4: Living Room

		Wake 	Leave 	Home 	Sleep 
Monday 	Zone 1	21.0C, 6:00AM	17.0C, 8:00AM	21.0C, 9:00PM	18.0C, 11:00PM
	Zone 2	21.0C, 6:00AM	17.0C, 8:00AM	21.0C, 8:00PM	18.0C, 10:00PM
	Zone 3	21.0C, 8:00AM	17.0C, 9:00AM	21.0C, 5:00PM	18.0C, 7:00PM
	Zone 4	--C, --:--AM	--C, --:--AM	21.0C, 5:00PM	18.0C, 9:00PM
Tuesday 	Zone 1	21.0C, 6:00AM	17.0C, 8:00AM	21.0C, 9:00PM	18.0C, 11:00PM
	Zone 2	21.0C, 6:00AM	17.0C, 8:00AM	21.0C, 8:00PM	18.0C, 10:00PM
	Zone 3	21.0C, 8:00AM	17.0C, 9:00AM	21.0C, 5:00PM	18.0C, 7:00PM
	Zone 4	--C, --:--AM	--C, --:--AM	21.0C, 5:00PM	18.0C, 9:00PM
Wednesday 	Zone 1	21.0C, 6:00AM	17.0C, 8:00AM	21.0C, 9:00PM	18.0C, 11:00PM
	Zone 2	21.0C, 6:00AM	17.0C, 8:00AM	21.0C, 8:00PM	18.0C, 10:00PM
	Zone 3	21.0C, 8:00AM	17.0C, 9:00AM	21.0C, 5:00PM	18.0C, 7:00PM
	Zone 4	--C, --:--AM	--C, --:--AM	21.0C, 5:00PM	18.0C, 9:00PM
Thursday 	Zone 1	21.0C, 6:00AM	17.0C, 8:00AM	21.0C, 9:00PM	18.0C, 11:00PM
	Zone 2	21.0C, 6:00AM	17.0C, 8:00AM	21.0C, 8:00PM	18.0C, 10:00PM
	Zone 3	21.0C, 8:00AM	17.0C, 9:00AM	21.0C, 5:00PM	18.0C, 7:00PM
	Zone 4	--C, --:--AM	--C, --:--AM	21.0C, 5:00PM	18.0C, 9:00PM
Friday 	Zone 1	21.0C, 6:00AM	17.0C, 8:00AM	21.0C, 9:00PM	18.0C, 12:00PM
	Zone 2	21.0C, 6:00AM	17.0C, 8:00AM	21.0C, 8:00PM	18.0C, 11:00PM
	Zone 3	21.0C, 8:00AM	17.0C, 9:00AM	21.0C, 5:00PM	18.0C, 11:00PM
	Zone 4	--C, --:--AM	--C, --:--AM	21.0C, 5:00PM	18.0C, 11:00PM
Saturday 	Zone 1	21.0C, 8:00AM	17.0C, 10:00AM	17.0C, 10:00PM	18.0C, 12:00PM
	Zone 2	21.0C, 8:00AM	17.0C, 10:00AM	21.0C, 8:00PM	18.0C, 11:00PM
	Zone 3	21.0C, 9:00AM	--C, --:--AM	--C, --:--PM	18.0C, 11:00PM
	Zone 4	21.0C, 9:00AM	--C, --:--AM	--C, --:--PM	18.0C, 11:00PM
Sunday 	Zone 1	21.0C, 8:00AM	17.0C, 10:00AM	17.0C, 10:00PM	18.0C, 11:00PM
	Zone 2	21.0C, 8:00AM	17.0C, 10:00AM	21.0C, 8:00PM	18.0C, 10:00PM
	Zone 3	21.0C, 9:00AM	--C, --:--AM	--C, --:--PM	18.0C, 7:00PM
	Zone 4	21.0C, 9:00AM	--C, --:--AM	--C, --:--PM	18.0C, 9:00PM



Reference Tables











User Settings

Zone 1: _____

Zone 3: _____

Zone 2: _____

Zone 4: _____

		Wake 	Leave 	Home 	Sleep 
Monday 	Zone 1				
	Zone 2				
	Zone 3				
	Zone 4				
Tuesday 	Zone 1				
	Zone 2				
	Zone 3				
	Zone 4				
Wednesday 	Zone 1				
	Zone 2				
	Zone 3				
	Zone 4				
Thursday 	Zone 1				
	Zone 2				
	Zone 3				
	Zone 4				
Friday 	Zone 1				
	Zone 2				
	Zone 3				
	Zone 4				
Saturday 	Zone 1				
	Zone 2				
	Zone 3				
	Zone 4				
Sunday 	Zone 1				
	Zone 2				
	Zone 3				
	Zone 4				



Dimplex North America Limited
1367 Industrial Road
Cambridge ON
Canada N3H 4W3

© 2016 Dimplex North America Limited